

DATE: 10-1-08

REVISIONS:

PROGRESS PRINT  
 10-3-08  
 ISSUED FOR REVIEW  
 10-10-08  
 ISSUED FOR PERMIT  
 11-24-08  
 REVISED 12-15-08  
 REVISED 1-4-09

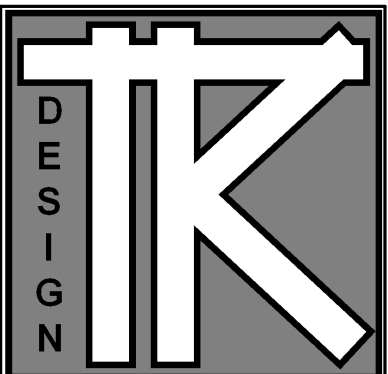

TODD KNUTSON DESIGN  
 2388 UNIVERSITY AV. W.  
 STUDIO 100  
 SAINT PAUL, MN. 55114  
 PHONE: 651-472-0054  
 FAX: 651-472-0060  
 MOBIL: 612-251-1041

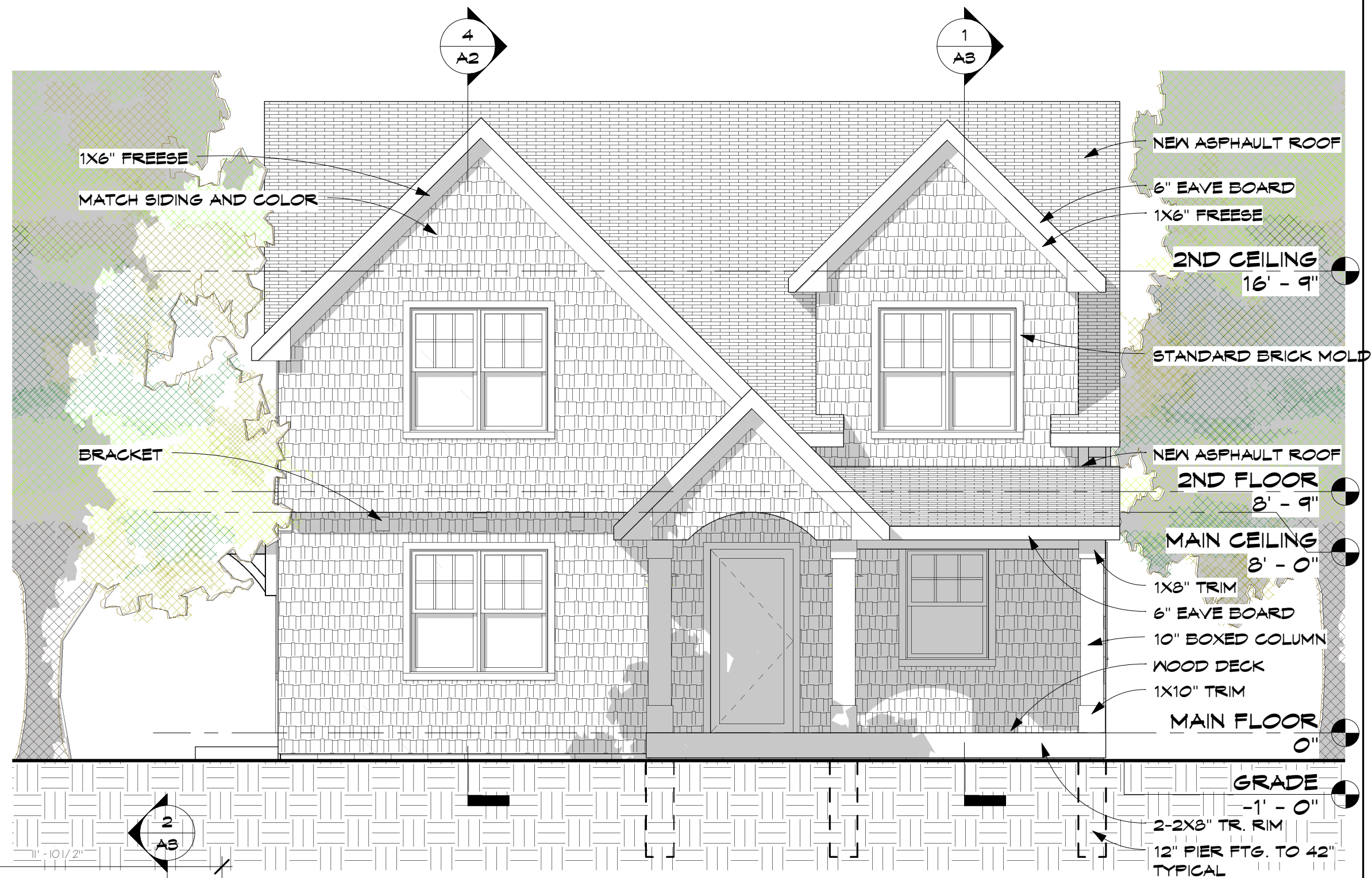
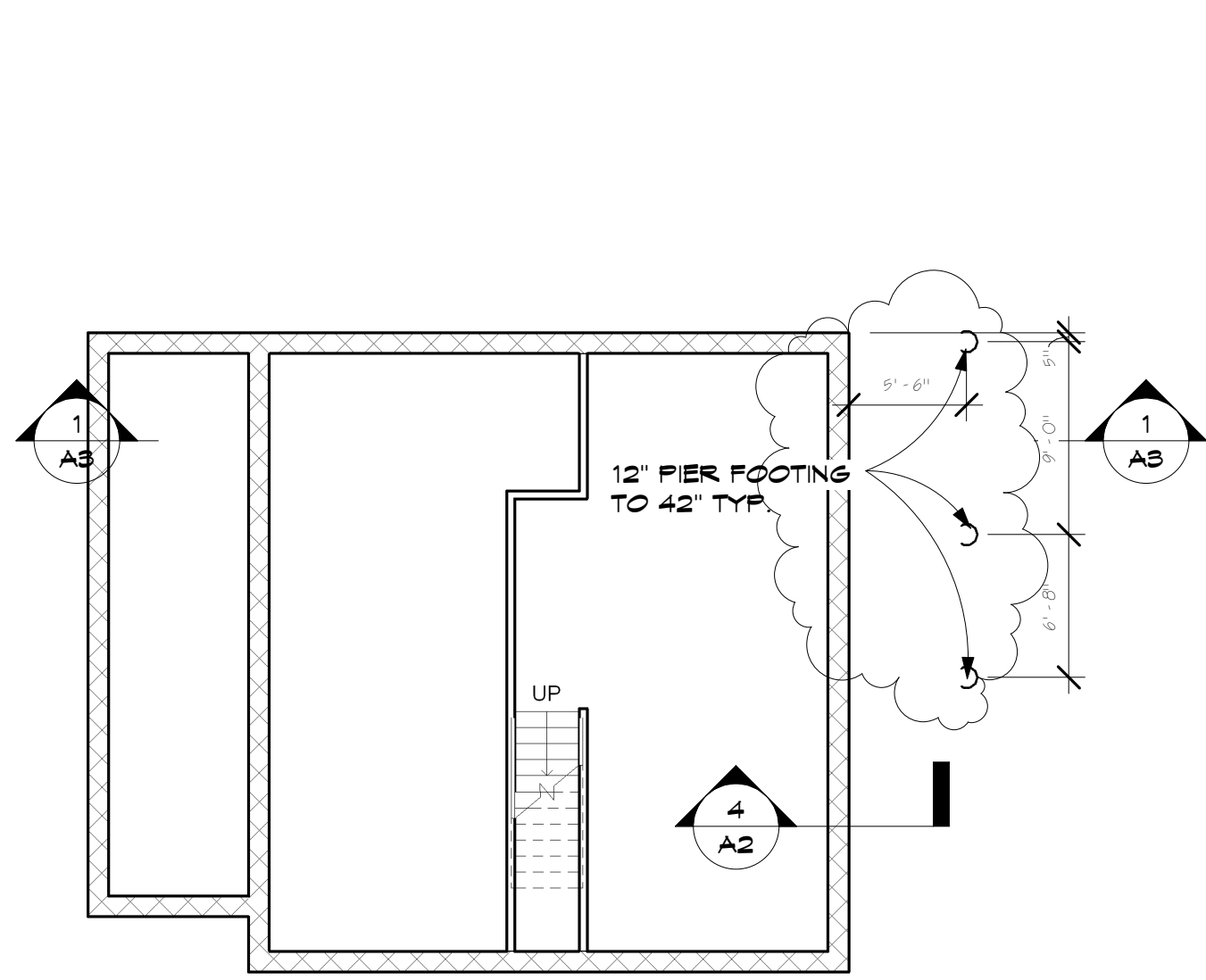

1 LOWER FLOOR  
 A1 1/8" = 1'-0"

4 EAST  
 A1 1/4" = 1'-0"

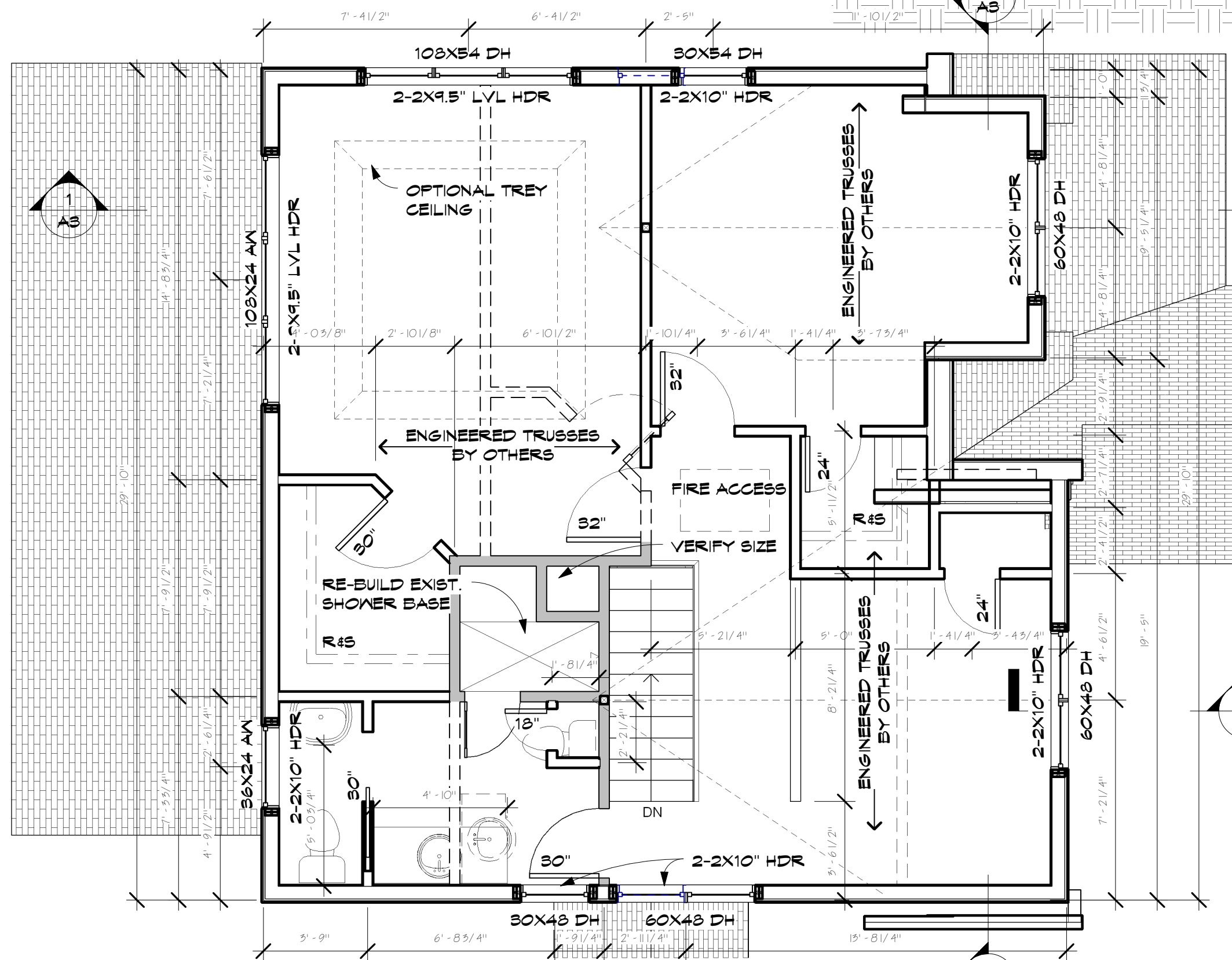

3 2ND FLOOR  
 A1 1/4" = 1'-0"

2 MAIN FLOOR  
 A1 1/8" = 1'-0"

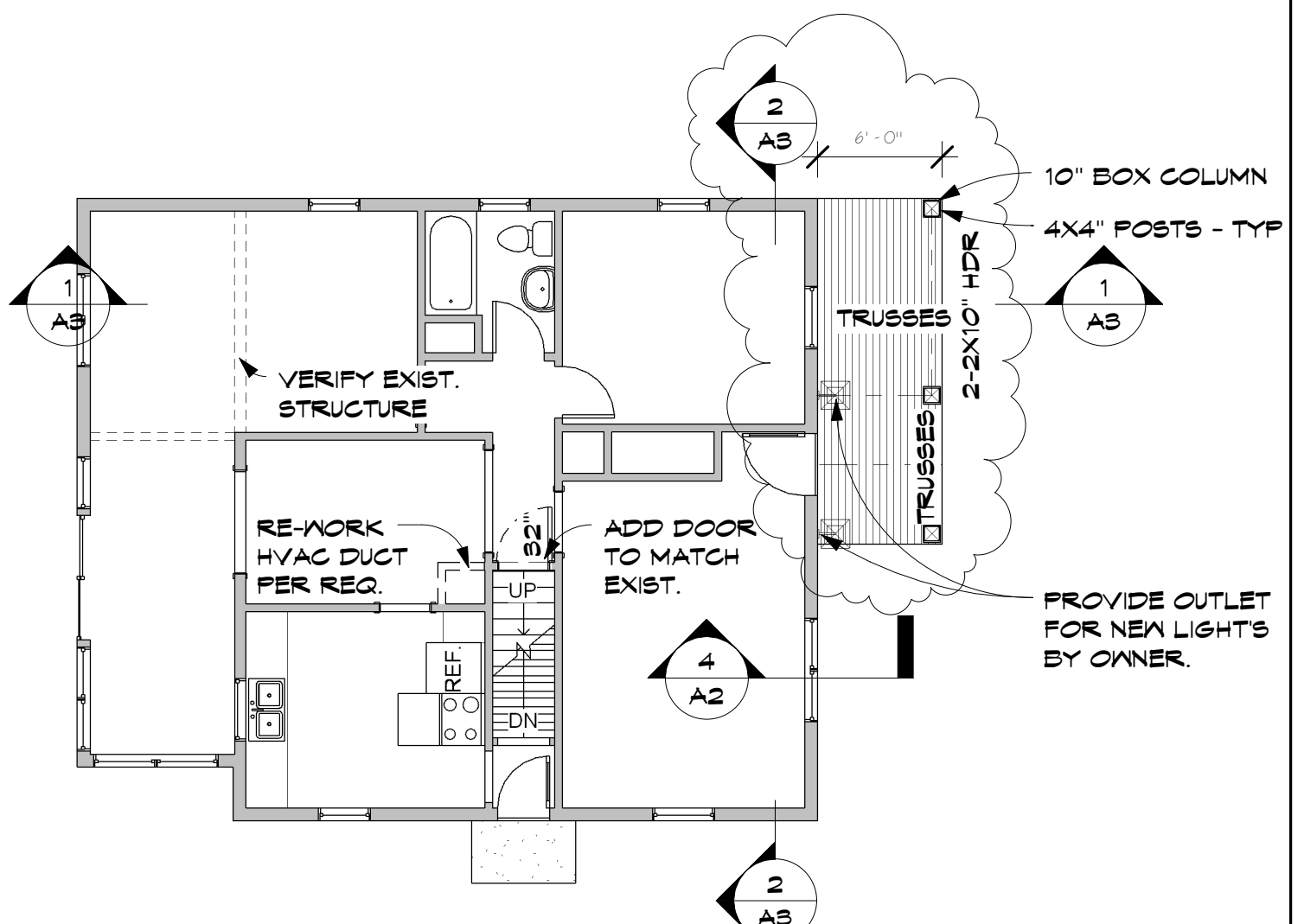

RICHMOND CURVE

5440 RICHMOND CURVE  
 MINNEAPOLIS, MN.

JOB NO: 5440

SHEET NO:

**A1**

PLANS



DATE: 10-1-08

REVISIONS:

ISSUED FOR REVIEW  
10-10-08  
ISSUED FOR PERMIT  
11-24-08  
REVISED 12-15-08  
REVISED 1-4-09

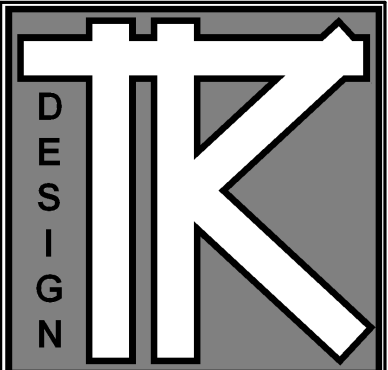

TODD KNUTSON DESIGN  
2388 UNIVERSITY AV. N.  
STUDIO 100  
SAINT PAUL, MN. 55114  
PHONE: 651-472-0054  
FAX: 651-472-0060  
MOBIL: 612-251-1041

RICHMOND CURVE

5440 RICHMOND CURVE  
MINNEAPOLIS, MN.

JOB NO: 5440

SHEET NO:

**A2**

ELEVATIONS



3 WEST  
A2 1/8" = 1'-0"

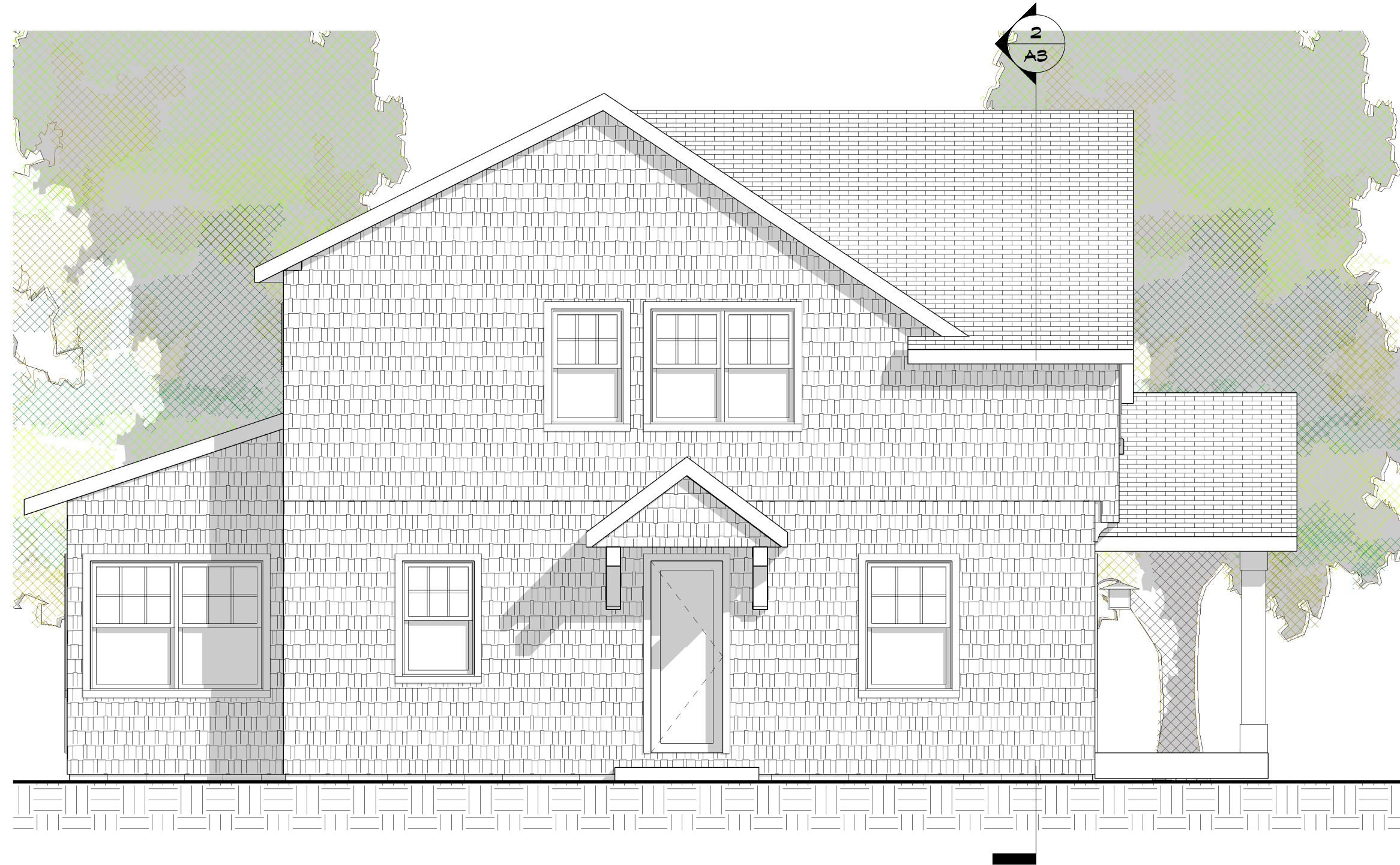

1 SOUTH  
A2 1/4" = 1'-0"

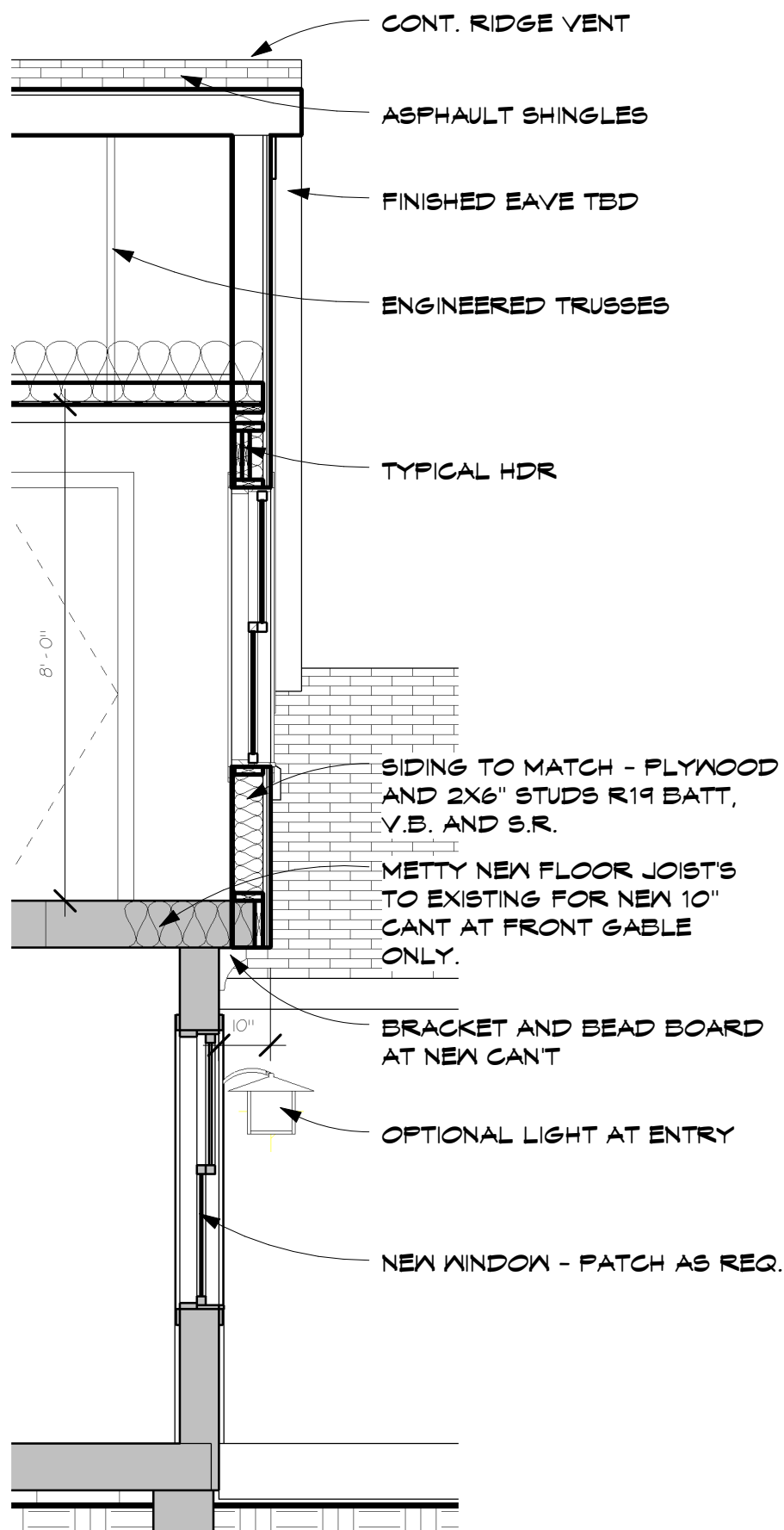

4 GABLE WALL DETAIL  
A2 3/8" = 1'-0"

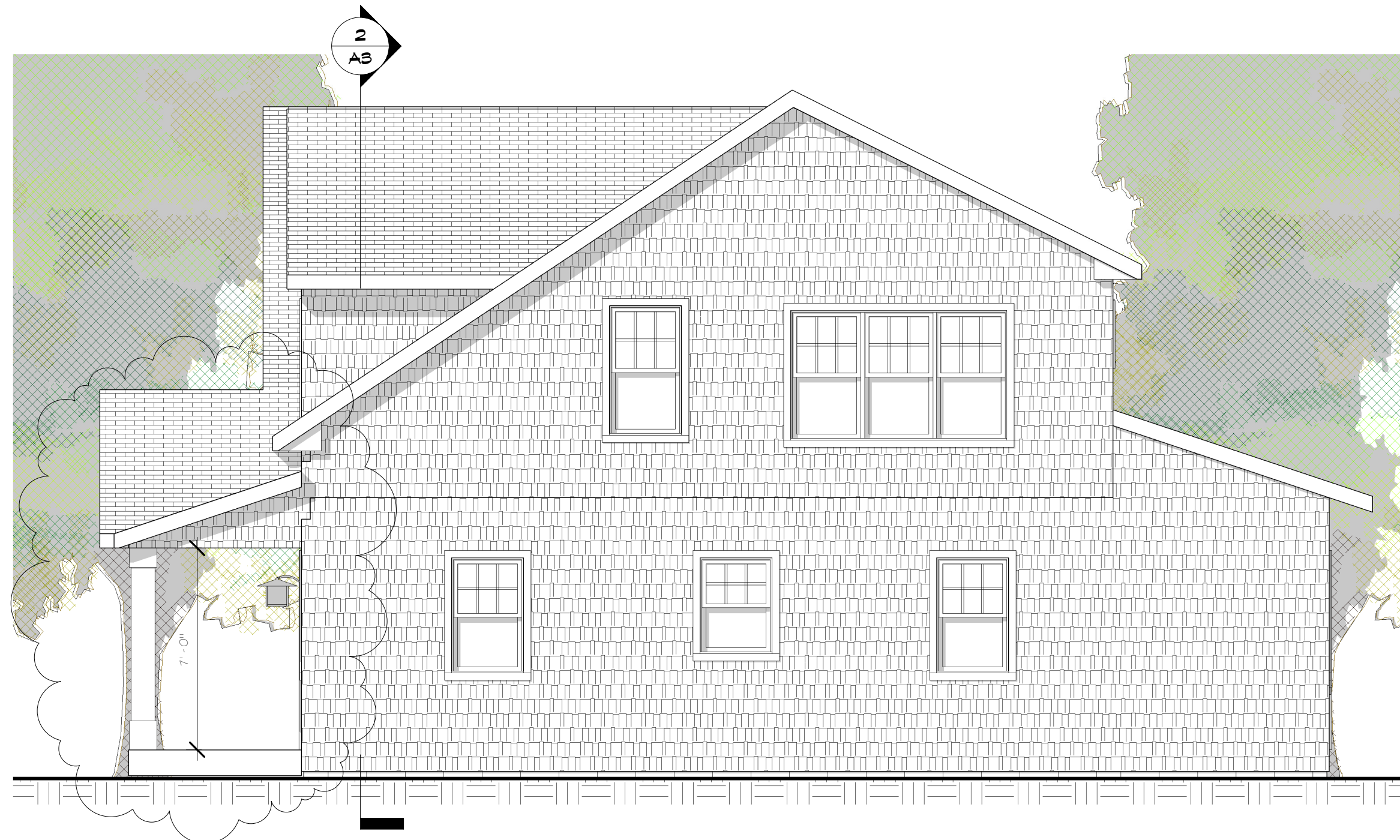

2 NORTH  
A2 1/4" = 1'-0"



DATE: 10-1-08

REVISIONS:

ISSUED FOR REVIEW  
10-10-08  
ISSUED FOR PERMIT  
11-24-08  
REVISED 12-15-08  
REVISED 1-4-09

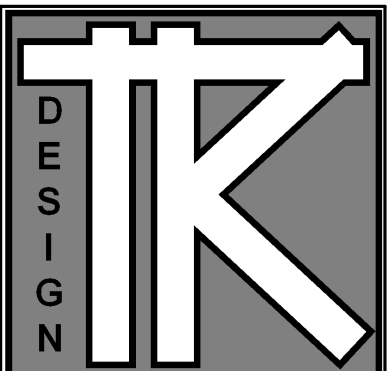

TODD KNUTSON DESIGN  
2388 UNIVERSITY AV. N.  
STUDIO 100  
SAINT PAUL, MN. 55114  
PHONE: 651-472-0054  
FAX: 651-472-0060  
MOBIL: 612-251-1041

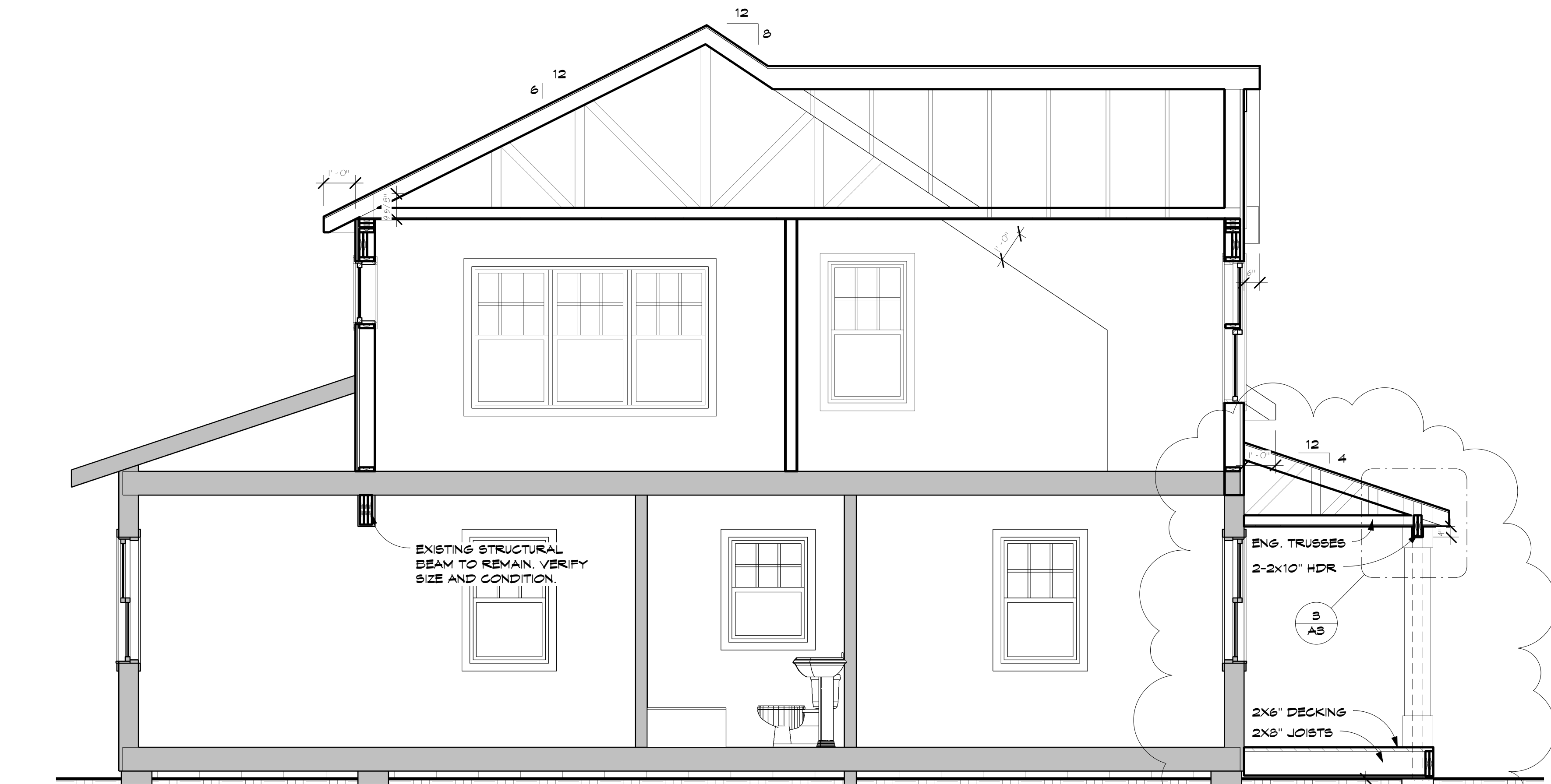

1 BUILDING SECTION 1  
A3 3/8" = 1'-0"

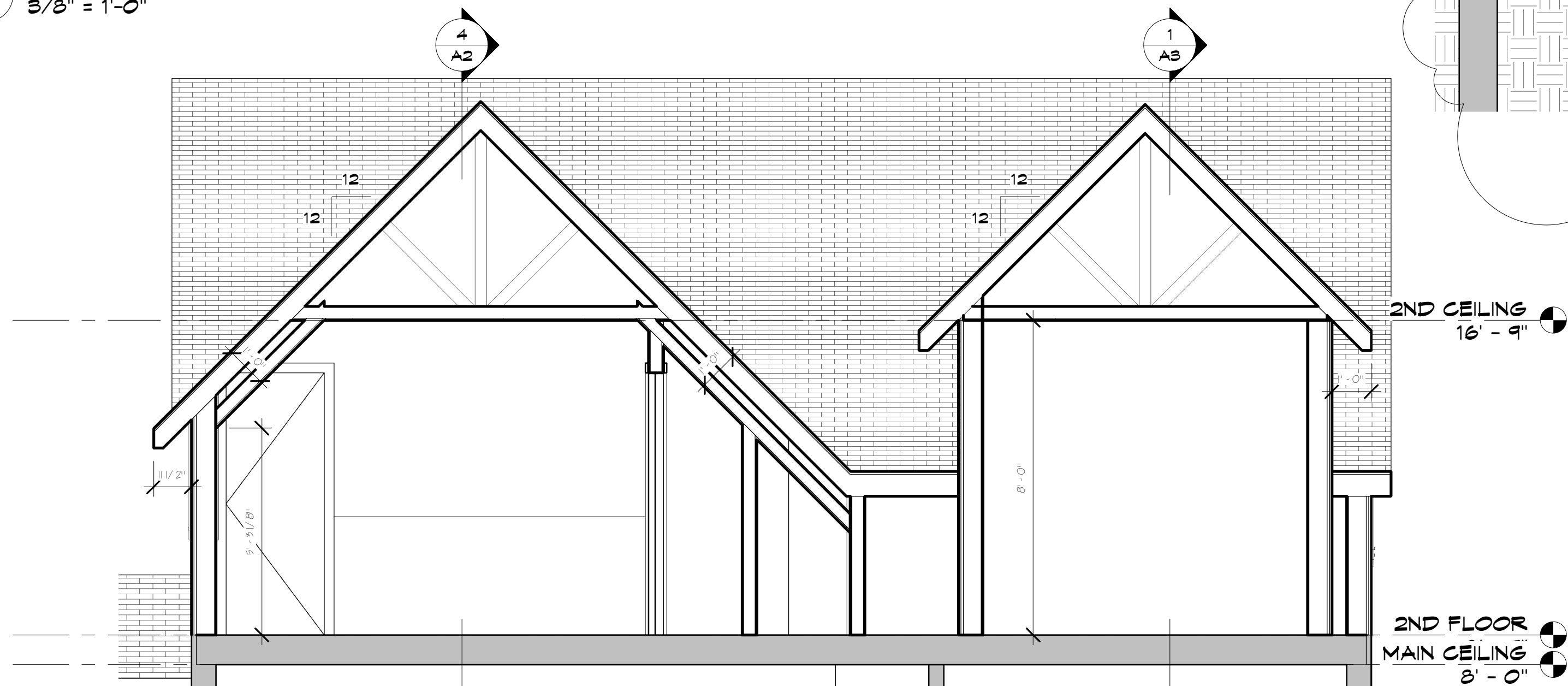

2 BUILDING SECTION 2  
A3 3/8" = 1'-0"

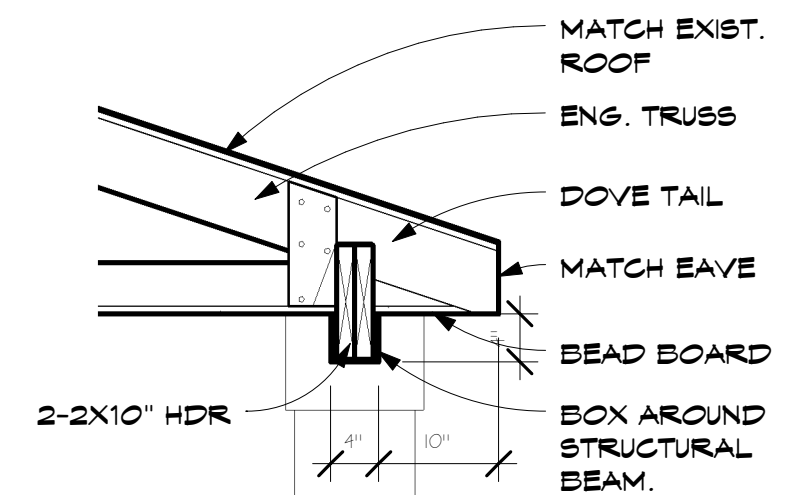

3 PORCH DETAIL  
A3 3/4" = 1'-0"

RICHMOND CURVE

5440 RICHMOND CURVE  
MINNEAPOLIS, MN.

JOB NO: 5440

SHEET NO:

A3

SECTIONS

# PROJECT NAME

DATE: 10-1-08

REVISIONS:

ISSUED FOR REVIEW  
10-10-08  
ISSUED FOR PERMIT  
11-24-08  
REVISED 12-15-08  
REVISED 1-4-09

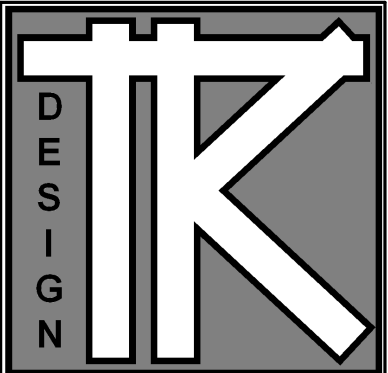

TODD KNUTSON DESIGN

2388 UNIVERSITY AV. N.  
STUDIO 100  
SAINT PAUL, MN. 55114  
PHONE: 651-472-0054  
FAX: 651-472-0060  
MOBIL: 612-251-1041

**RICHMOND CURVE**

5440 RICHMOND CURVE  
MINNEAPOLIS, MN.

JOB NO: 5440

SHEET NO:

**T**

TITLE